

30 to 1,300 psi (207 to 8,970 kPa)



Description & Features:

- One-piece design - no internal gaskets or o-rings
- Diaphragm is flush to the gasket sealing surface so no internal cavities for media buildup
- Various sizes available
- ASME B40.100 compliant
- 1 year warranty

Applications:

- Oil refineries, pulp and paper mills, chemical plants
- Where media buildup is a concern

Specifications	
Housing	316 SS
Diaphragm	316L SS bonded to housing
Construction	One piece construction
Connection	1/4", 1/2" NPTF gauge connections standard 1.5" (40mm), 2" (50mm) and 3" (75mm) pipe size
Maximum Temperature Limit	450°F (232°C)

Order Codes

Type	Instrument Connection	Code
2" - 150#RF	1/4" NPTF	D462548
	1/2" NPTF	D462549
2" - 300#RF	1/4" NPTF	D462550
	1/2" NPTF	D462551
2" - 600#RF	1/4" NPTF	D462552
	1/2" NPTF	D462553
3" - 150#RF	1/4" NPTF	D462554
	1/2" NPTF	D462555
3" - 300#RF	1/4" NPTF	D462556
	1/2" NPTF	D462557
3" - 600#RF	1/4" NPTF	D462558
	1/2" NPTF	D462559

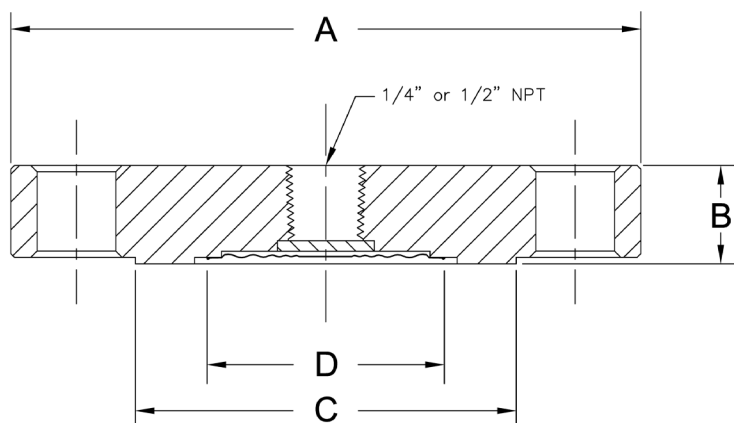

Pipe Size	Rating	A	B	C	D
2"	150#	6"	0.88"	3.6"	2.2"
	300#	6.5"	0.88"		
	600#		1.25"		
3"	150#	7.5"	0.94"	5"	2.2" or 3"
	300#	8.2"	1.12"		
	600#		1.5"		

Other sizes available upon request