

30 to 600 psi (200 to 4,140 kPa)



Description & Features:

- Meets the requirements of dairy, food, beverage, chemical and pharmaceutical industries
- 3A approved
- ASME B40.100 compliant
- CRN registered
- 1 year warranty

Applications:

- D20 may be attached to any Winters all SS gauge for sanitary installations.

Specifications

Housing	AISI 316 SS
Diaphragm	AISI 316L SS, welded
Minimum Operating Pressure	30 psi (200 kPa)
Maximum Operating Pressure	600 psi (4,140 kPa)
Gauge Connection	1/4" NPTF
Process Connection	1.5" (40mm) and 2" (50mm) Tri-Clamp® fitting standard
Process Temperature	-4°F to 248°F (-20°C to 120°C)
Surface Finish	8 Ra

Order Codes

1.5" (40mm)	2" (50mm)
D20980	D20976

Option suffix for above order codes only:

SF-D = Silicone fill (seal only)

1.5" Tri-Clamp®

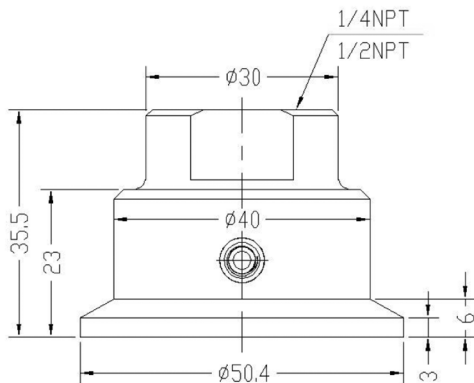

2" Tri-Clamp®

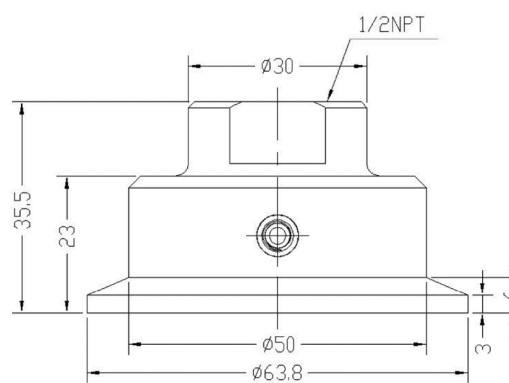

Tri-Clamp® is a registered trademark of Tri-Clover