



Description & Features:

- Designed for use with all 9" (230mm) industrial thermometers to create a "sealed system"
- Allows the easy replacement of thermometers without the need to shut down or drain the system
- CAN/CGSB-14.4-M88 compliant
- CRN registered
- 1 year warranty

Applications:

- HVAC, pipes, chill water and hot water lines
- Lead free version for potable water systems



Note: RoHS applies only to 304 SS and 316 SS thermowells

Specifications

Material	TIW: Brass, AISI 304 SS, AISI 316 SS TIW-LF: Lead free brass
Bore Diameter	7/16" tapered
Form	Stepped standard, straight available
Thermometer Connection	1-1/4" UNF
Process Connection	3/4" NPTM standard
Warning (brass and lead free brass thermowells only)	WARNING: This product can expose you to chemicals including lead, which is known to the State of California to cause cancer and birth defects or other reproductive harm. For more information go to www.P65Warnings.ca.gov .

TIW Thermowell Order Codes (products in bold are normally stock in North America)

Stem Length	Overall Length	Material	Insertion Length	Lagging Extension	1/2" NPT Connection	3/4" NPT Connection
3.5" Without Lagging	4.25" (108mm)	Brass	2.5" (63mm)	-	-	TIW01
		304 SS			-	TIW01-1
		316 SS			-	TIW01-2
3.5" With Lagging	4.25" (108mm)	Brass	1.75" (44mm)	1" (25mm)	TIW02	TIW03
		304 SS			TIW02-1	TIW03-1
		316 SS			TIW02-2	TIW03-2
6" Without Lagging	6.75" (172mm)	Brass	5" (127mm)	-	-	TIW04
		304 SS			-	TIW04-1
		316 SS			-	TIW04-2
6" With Lagging	6.75" (172mm)	Brass	2.5" (63mm)	2.5" (63mm)	-	TIW07
		304 SS			-	TIW07-1
		316 SS			-	TIW07-2

TIW-LF Thermowell Order Codes (products in bold are normally stock in North America)

Stem Length	Overall Length	Material	Insertion Length	Lagging Extension	3/4" NPT Connection
3.5" Without Lagging	4.25" (108mm)	Lead Free Brass	2.5" (63mm)	-	TIW01LF
3.5" With Lagging		Lead Free Brass	1.75" (44mm)	1" (25mm)	TIW03LF
6" Without Lagging	6.75" (172mm)	Lead Free Brass	5" (127mm)	-	TIW04LF
6" With Lagging		Lead Free Brass	2.5" (63mm)	2.5" (63mm)	TIW07LF

Other configurations available. Other threads available upon request. Longer thermowells available upon request. Other materials such as Monel®, Inconel®, Hastelloy® C and Titanium are available upon request.

Option suffix:

W61 = Brass cap and chain (1.25" UNF)
W61-1 = SS cap and chain (1.25" UNF)

Hastelloy® is a registered trademark of Haynes International, Inc.
Inconel® is a registered trademark of Special Metals Corporation
Monel® is a registered trademark of Inco Alloys International

3.5" Stem Without Lagging

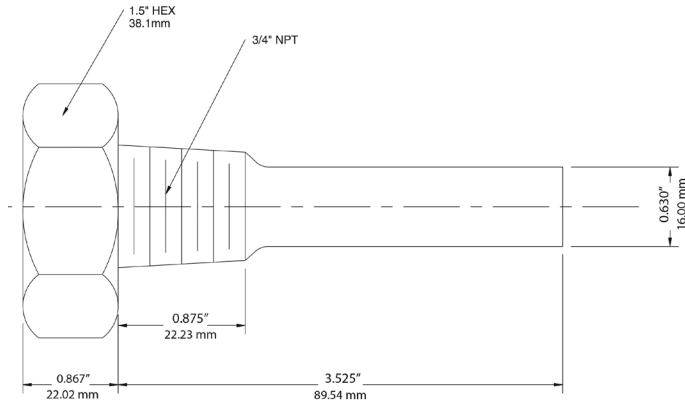

3.5" Stem With Lagging

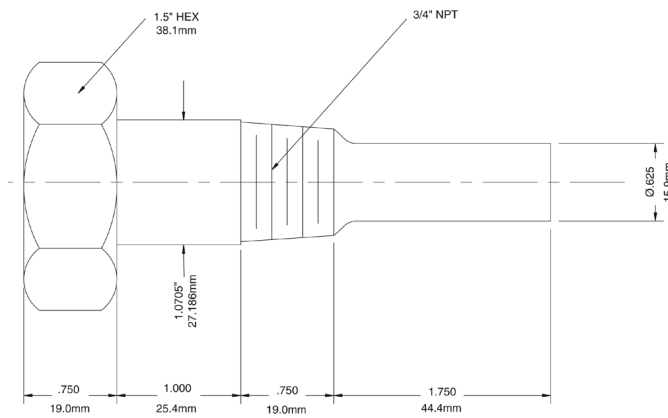

6" Stem Without Lagging

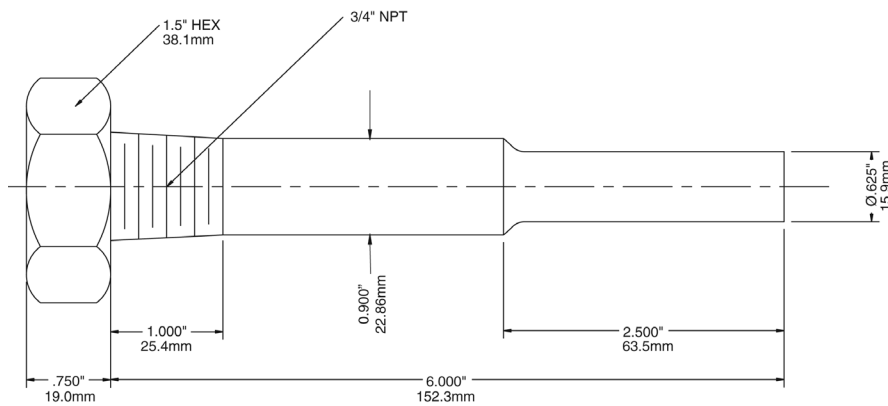

6" Stem With Lagging

