

Description & Features:

- Incorporates a sintered, porous 316 stainless steel snubbing element with a large surface area to ensure long term effectiveness
- Available in the three standard viscosity classifications of heavy oil, water and air
- Brass, lead free brass or stainless steel housings can be specified depending upon pressure media and operating pressure
- ASME B40.100 compliant
- CRN registered
- 1 year warranty

Applications:

- To significantly lessen the damaging effects of pulsation on gauges, transducers, transmitters, manometers and pressure switches
- Lead free version for potable water systems



Note: RoHS applies only to 316 SS version

Specifications	SS	Brass
Operating Temperature	-320°F to 1,500°F (-195°C to 815°C)	-65°F to 650°F (-53°C to 343°C)
Operating Pressure	Maximum 20,000 psi (137,900 kPa)	Maximum 10,000 psi (68,950 kPa)
Burst Pressure	60,000 psi (413,700 kPa)	30,000 psi (206,850 kPa)
Housing	316 SS	SSN: Brass SSN-LF: Lead free brass
Snubbing Element	Sintered, porous type 316 SS	Sintered, porous type 316 SS
Retainer	300 series SS	300 series SS
Warning (brass internals only)	N/A	WARNING: This product can expose you to chemicals including lead, which is known to the State of California to cause cancer and birth defects or other reproductive harm. For more information go to www.P65Warnings.ca.gov .

SSN Order Codes (products in bold are normally stock in North America)

Model	Heavy Oil	Water	Air
1/4" Brass	SSN517	SSN515	SSN516
1/4" SS	SSN520	SSN518	SSN519
1/2" Brass	SSN514	SSN512	SSN513
1/2" SS	SSN531	SSN529	SSN530

SSN-LF Order Codes (products in bold are normally stock in North America)

Model	Water
1/4" Brass	SSN515LF
1/2" Brass	SSN512LF

1/4" Snubber

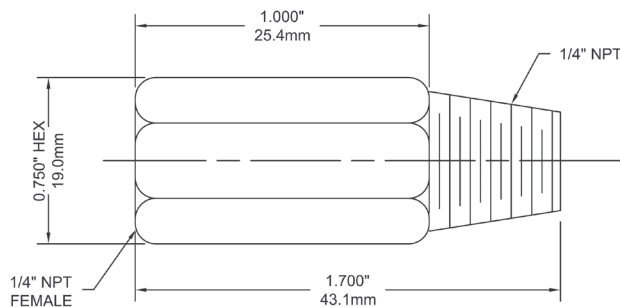

1/2" Snubber

